

Cobham Microwave

29 avenue de la Baltique
91953 Courtaboeuf, FRANCE

The most important thing we build is trust

COBHAM



Evaluation and Qualification of Ferrite Isolators and Circulators for Space Applications

Jean-Marc BUREAU, Aurélie BOISSE, Savas KURT, Eric LAROCHE

- FERRITE CIRCULATORS AND ISOLATORS
- ECI OBJECTIVES AND WORK PROGRAMME
 - DEVELOPMENT
 - ESCC EVALUATION
 - ESCC QUALIFICATION
- SUMMARY AND CONCLUSIONS

Ferrite Isolators and Circulators

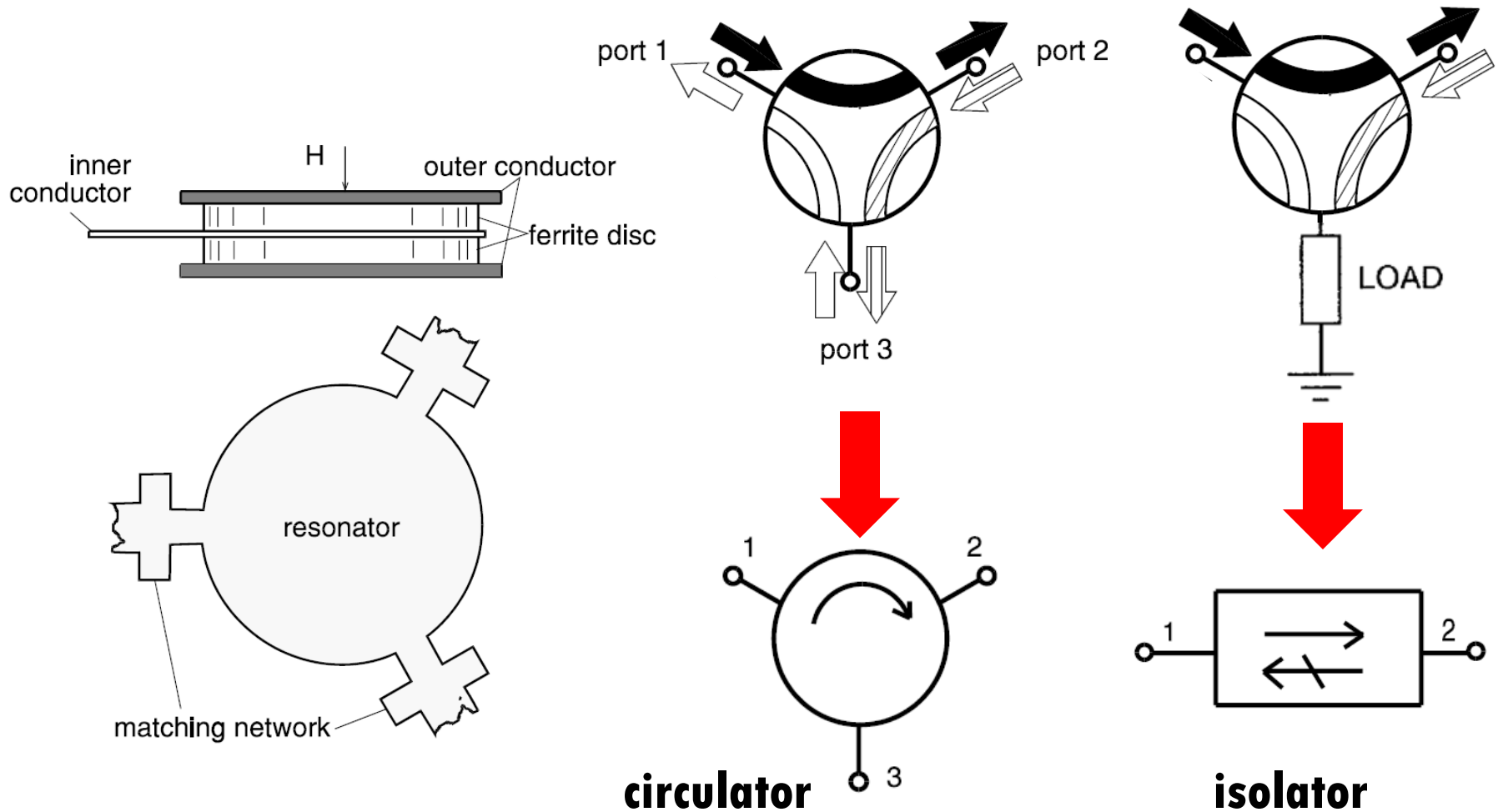

Cobham Microwave Isolators and Circulators

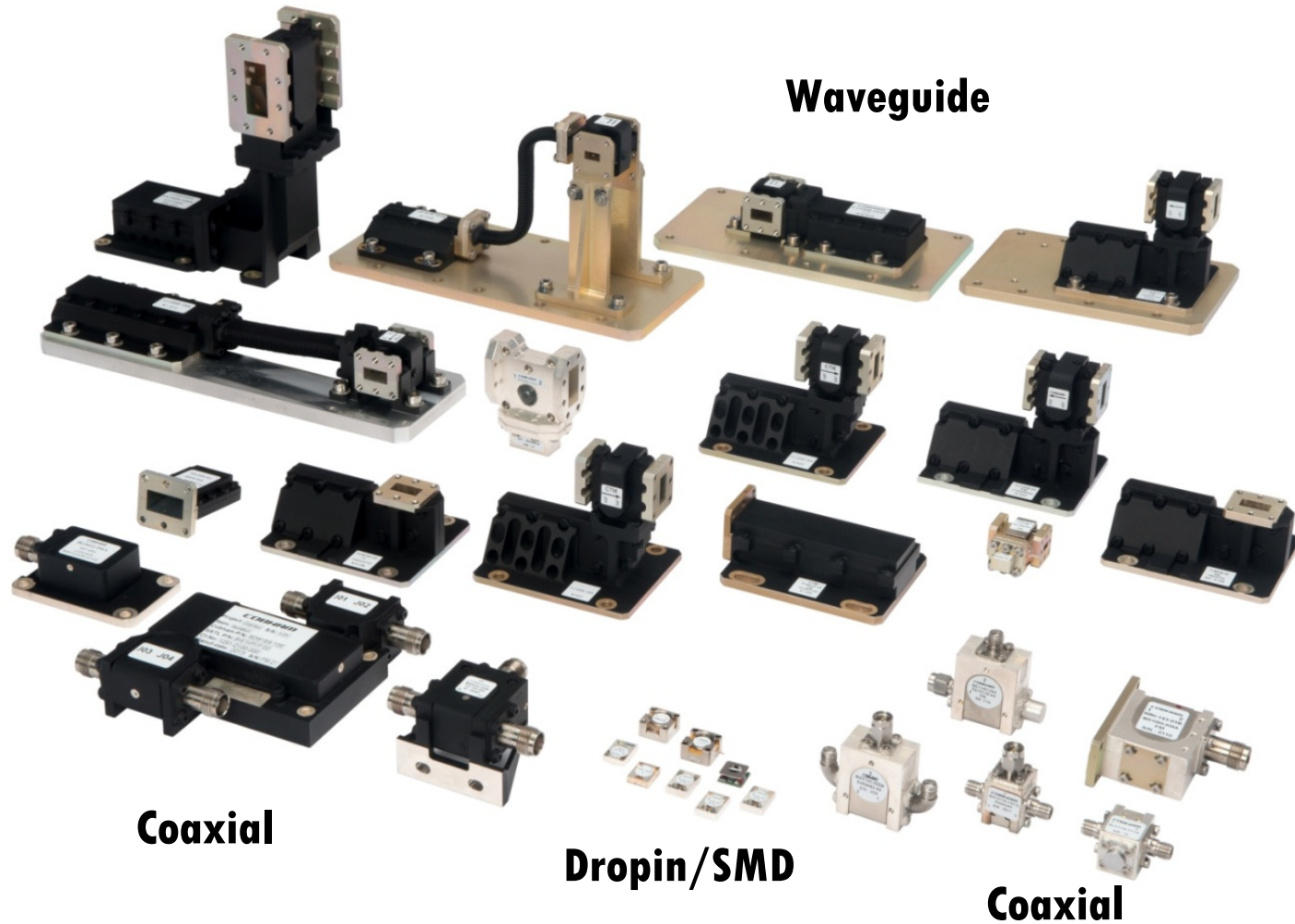

SCOPE

ESA EUROPEAN COMPONENT INITIATIVE (ECI 3)

BACKGROUND:

- No ESCC qualified isolator/circulator in the EQPL
- CTB RF Passive Working Group: update of ESCC3202 & Roadmaps
- TRP Project: Evaluation of Failure modes of ferrite isolators and circulators

OBJECTIVES:

- Develop high performance circulators and isolators
 - Contract 4000107044/12/NL/SFe Ka band Low Power
 - Contract 4000107378/12/NL/SFe High power S & C bands
- ESCC Evaluation and Qualification
- Construction Analysis
- Full documentation (Detail spec, PID, ...)
- ESCC Audit
- ESCC QPL Introduction

DEVELOPMENT

	LP Ka band	HP S band	HP C band
Frequency (BW)	22-32 GHz (14%)	2.0-2.7 GHz (0.4 GHz)	3.4-4.8 GHz (0.5 GHz)
Operating temperature	-30°C/+85°C	-30°C/+90°C	-30°C/+90°C
Power handling (CW)	1W fwd, 0.5W rev	200W	160W
Return loss	> 23 dB	> 20 dB	> 20 dB
Isolation	> 23 dB	> 20 dB	> 20 dB
Insertion loss	< 0.6 dB	< 0.3 dB	< 0.3 dB
Shielding effectiveness	> 70 dBi	> 70 dBi	> 70 dBi
Features	SMA 2.9 connectors Small footprint (integrated load) Glitch free 21 g	TNC connectors Glitch free 300 g Multipactor free	TNC connectors Glitch free 280 g

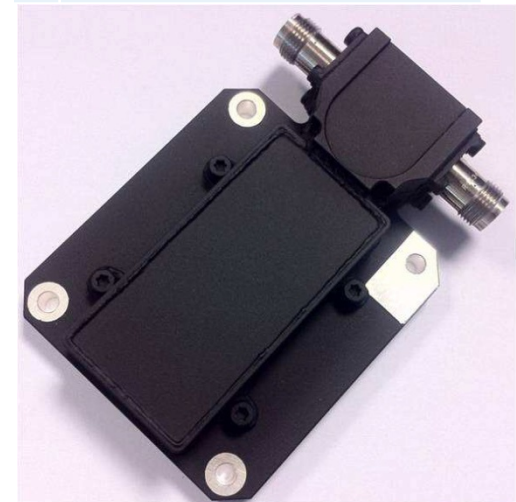
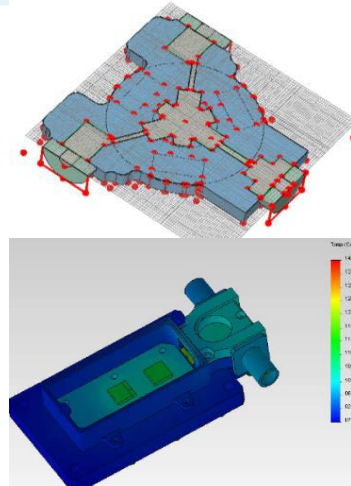
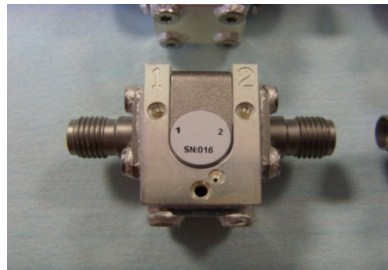
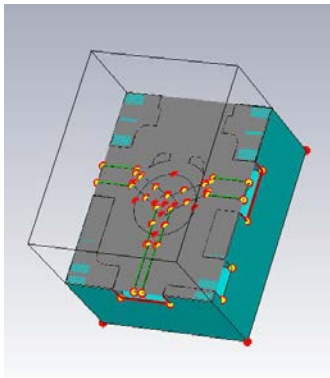

RF & thermal simulation, prototyping

ESCC Evaluation

- **Un-screened components**
- **Destructive tests:**
 - **Temperature and power step stress tests**
 - **Special test: Vibration, mechanical & thermal shocks**
- **Destructive physical analysis**
- **Accelerated electrical endurance test**
- **Evaluation of margins vs qualification levels**
- **If successful: introduction in EPPL**

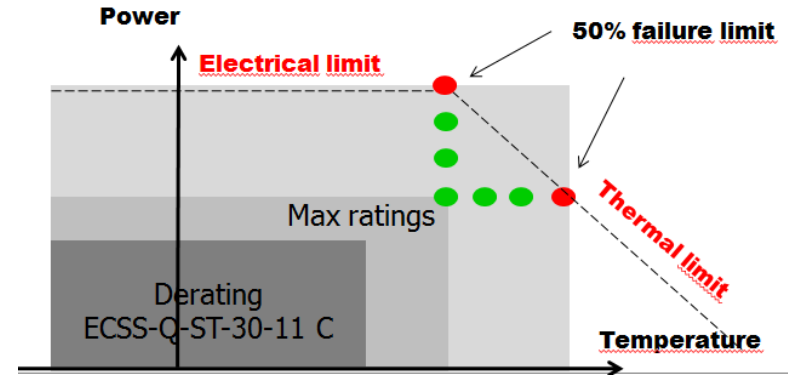

Test	Screening	Qualification
Non operating		
Vibration	Random 36 grms	Random 50 grms
Shocks	NA	1500 g, 0.3 ms
Thermal shocks	5 cycles Storage range	200 cycles Storage range
Operating		
Power Thermal test (high power only)	Max Power (forward, reverse and short circuit) Max op T, vacuum, 1H	Max Power (forward, reverse and short circuit) Max op T, vacuum, 6H
Operating life	NA	Max reverse Power, Max op T 1h on/ 1h off. 1000 H

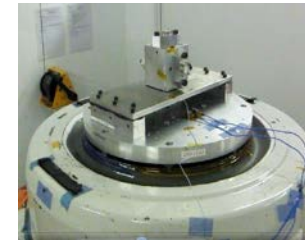

Evaluation Test Plan: LP isolator Ka band

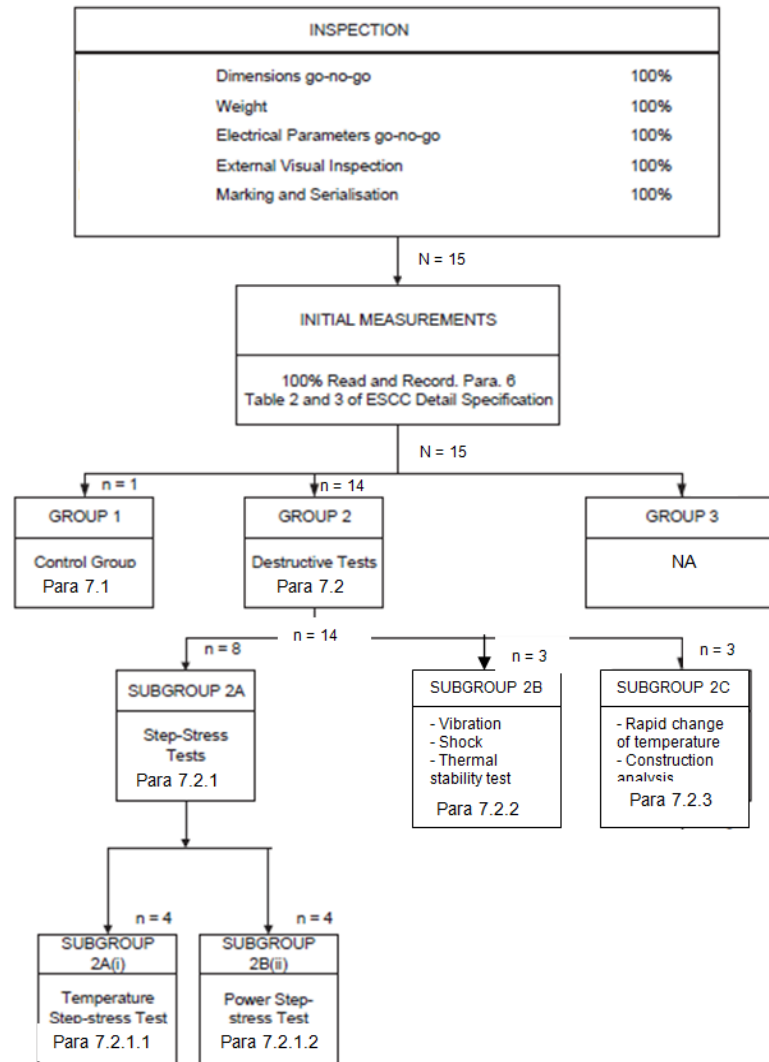
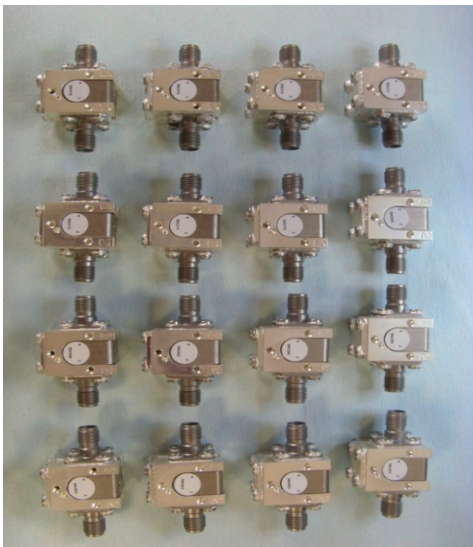

- **Low power absorptive load**
- **No power endurance testing (Group 3 non applicable)**

Evaluation Test Plan: HP isolator S & C bands



- **High power resistive load**
- **Power endurance testing**
- **Corona and multipactor testing**

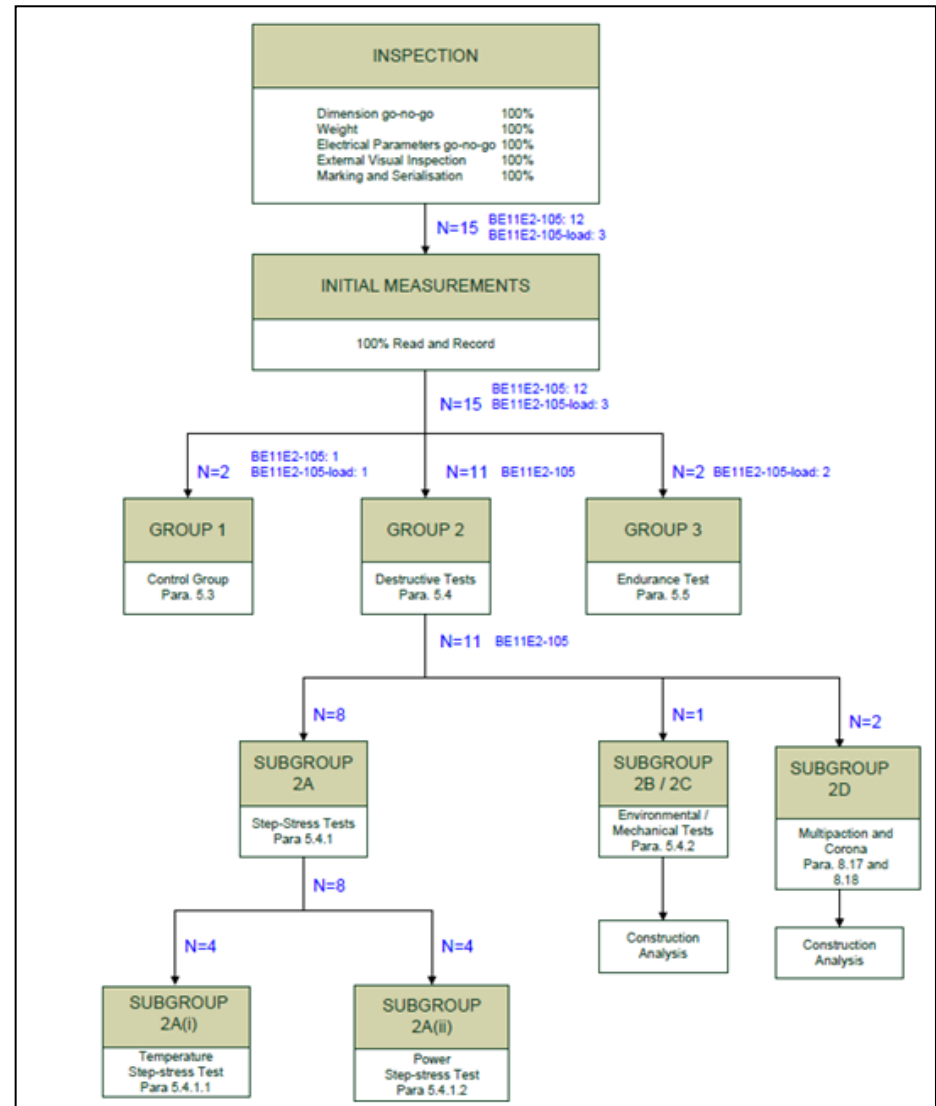

Power Testing: HP isolator S & C bands

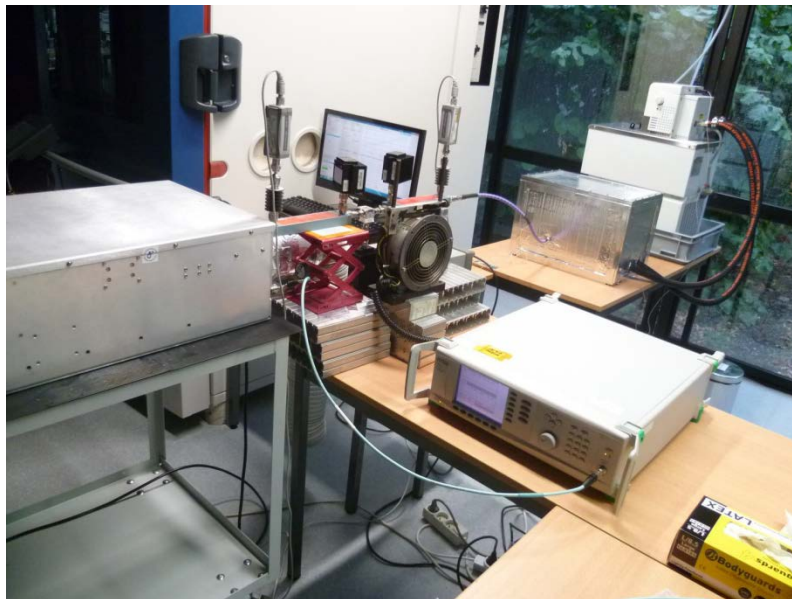
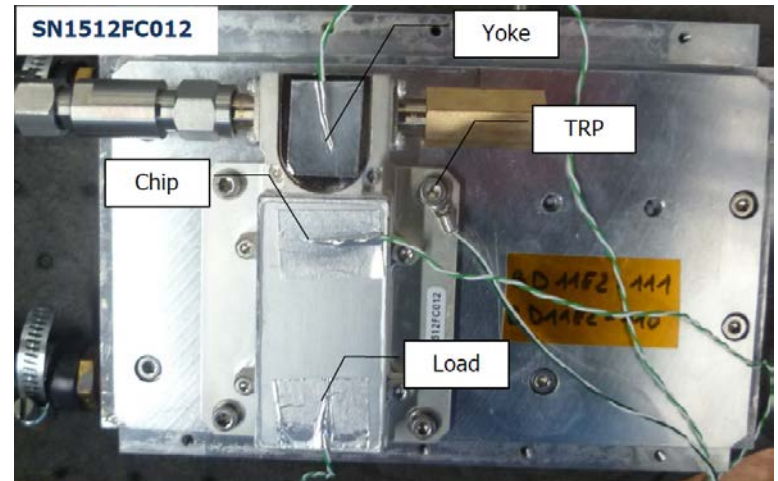
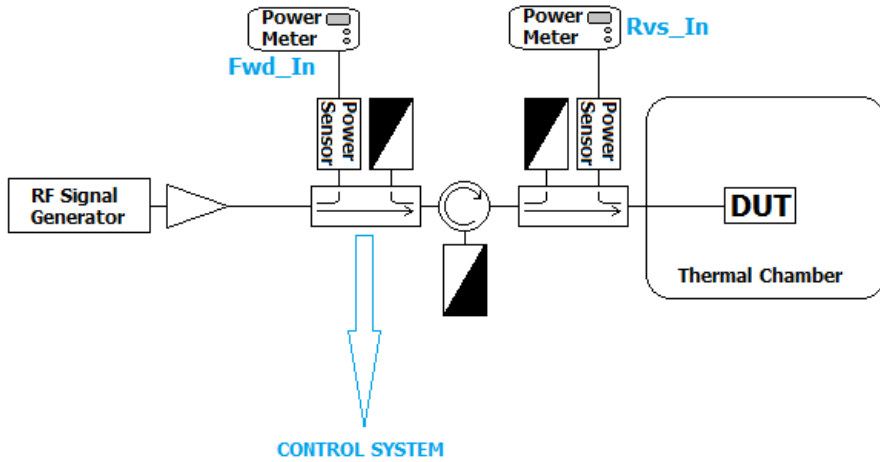

Multipactor testing: HP isolator S & C bands

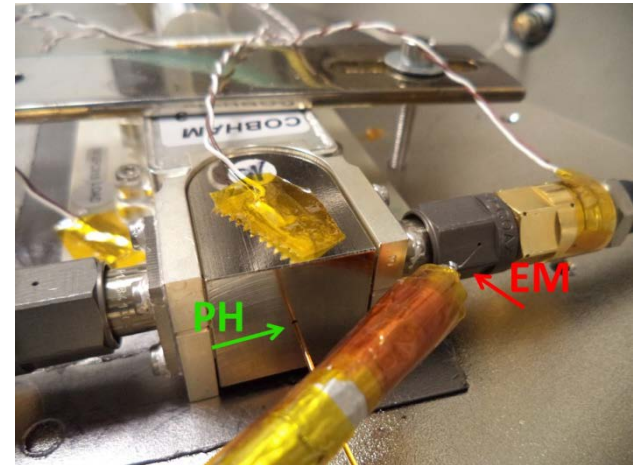
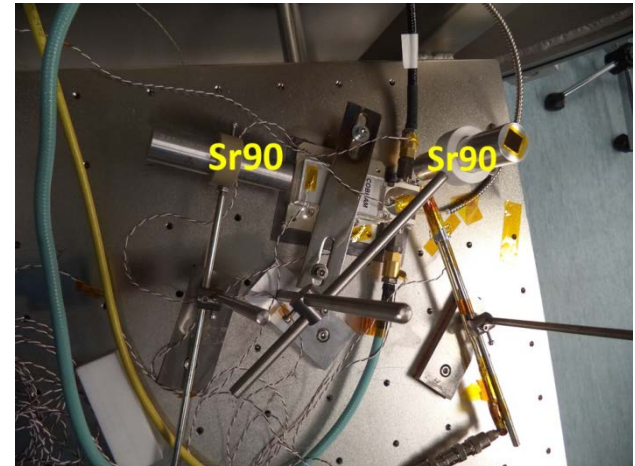
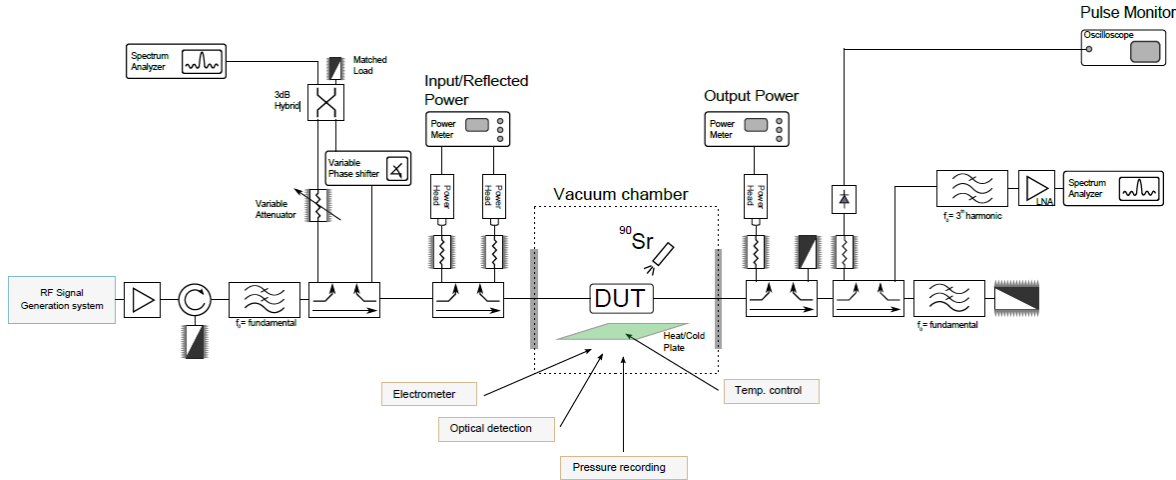

Evaluation results: Low Power Isolator Ka band

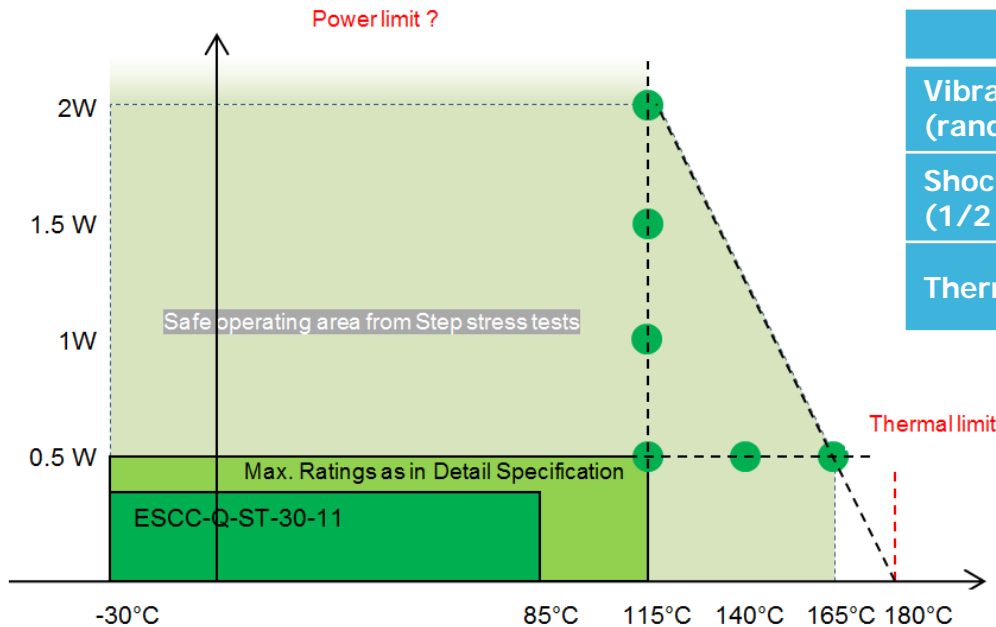

	Limit	Qual level
Vibration (random)	> 100 grms	50 grms
Shock (1/2 sine, 0.3 ms)	> 3000 g	1500 g
Thermal shocks	> 300 cycles -50°C/+125°C	200 cycles -40°C/+85°C

- Power step stress testing limited by equipment (SSPA in Ka band)
- Temperature step stress testing limited by materials (organic materials, solder)
- Mechanical testing limited by equipment (shaker)
- Cracks in adhesives revealed after TC by DPA -> design improvement before qualification

Evaluation results: High Power Isolators S & C bands

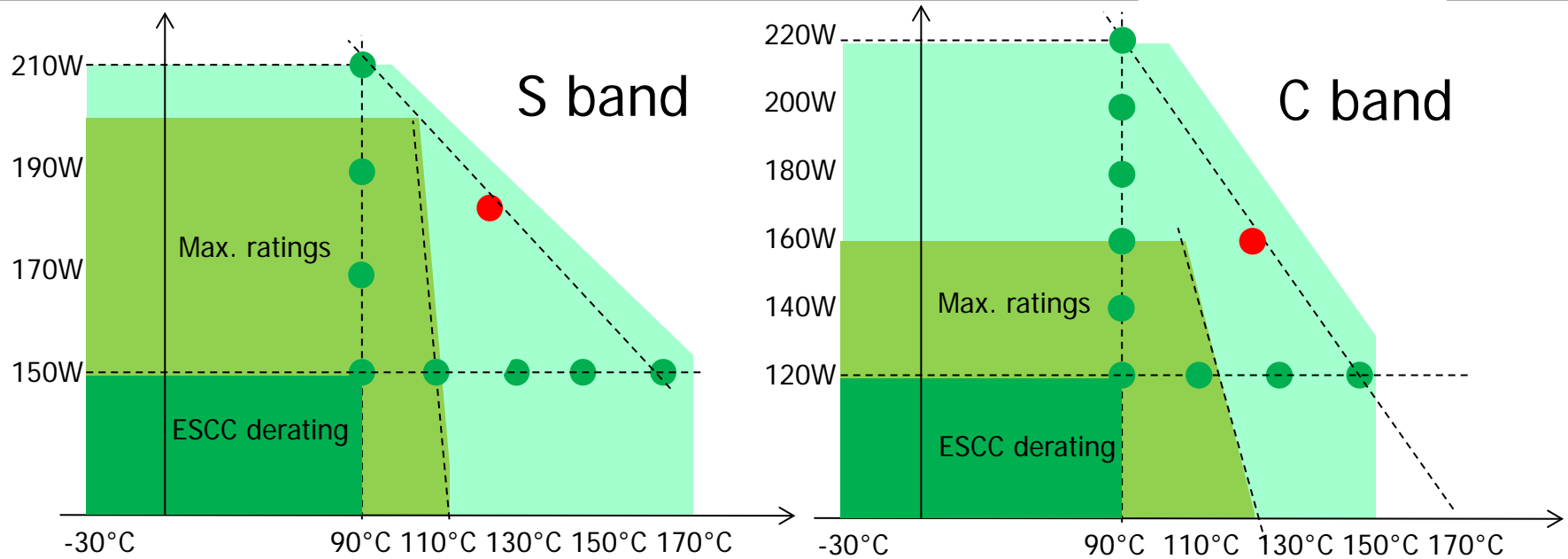

	Evaluation Limit	Qualification Level
Vibration (random)	> 50 grms	50 grms
Shock (1/2 sine, 0.3 ms)	> 3000 g	1500 g
Thermal shocks	> 500 cycles -40°C/+125°C	200 cycles -40°C/+85°C
Operating life tests 1000H @ 125°C	S band 180W C band 160W	120W 96W

Power levels	Rating
Corona	S band : 60W C band : 50W
Multipactor	S band : 600W C band : 480W TBC during qualification
Maximum rating (CW)	S band : 200W C band : 160W

Qualification

CHART F4 - QUALIFICATION AND PERIODIC TESTS

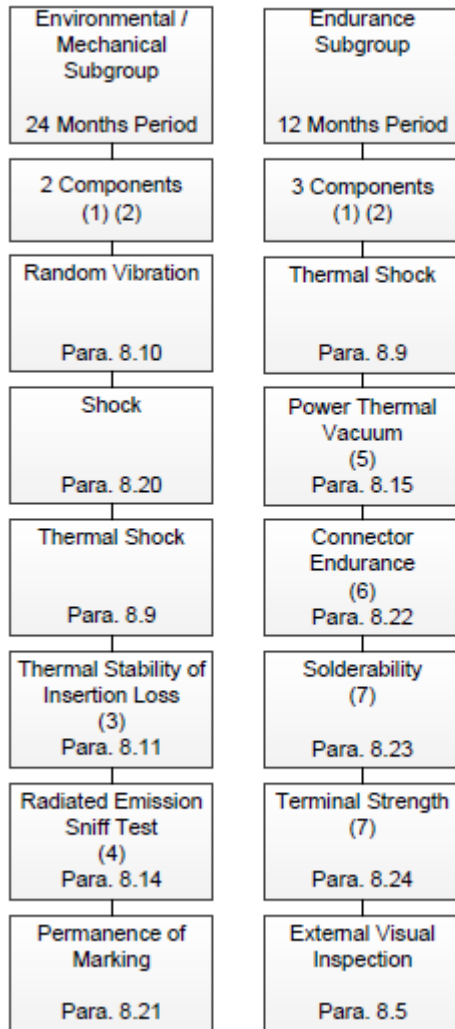

- **Verification on first production lot**
- **Screened components**
- **No failure allowed**



Low Power Ka band: qualification successful

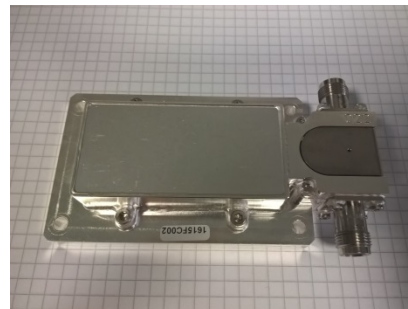

High Power S & C bands: qualification tests ongoing

Qualification activities

- **ESCC audit (ESA & CNES, Manufacturing and test activities)**
- **Documentation (ESCC detail spec, PID, FMECA, ...)**
- **Construction analysis**



ISOLATORS AND CIRCULATORS, LOW POWER,
Ka-BAND (22GHz – 32GHz), WITH NON-INTEGRAL
SMA 2.9 COAXIAL CONNECTORS

BASED ON TYPES BK1XXX AND BK3XXX

ESCC3202/026

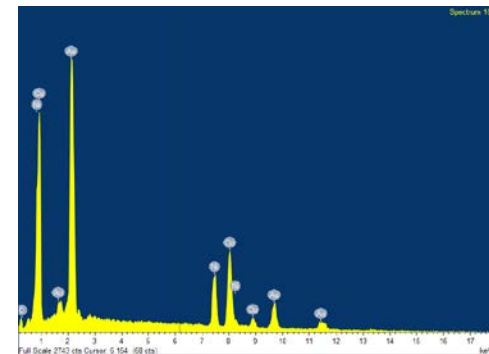
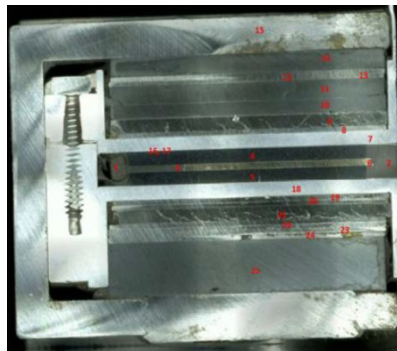
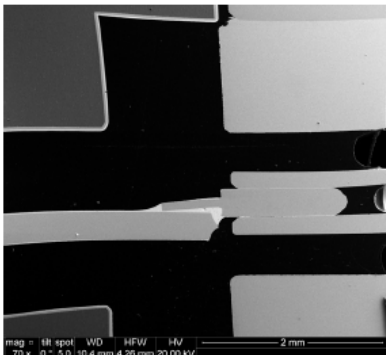
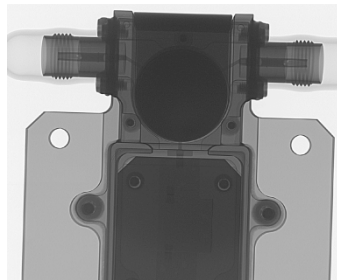

SUMMARY AND CONCLUSIONS

- **Full ESCC evaluation performed on high and low power ferrite isolators**
- **ESCC 3202 (Issue 2) Qualification levels confirmed, margins quantified**
 - **Operating (power, thermal)**
 - **Environment (vibration, shock, thermal cycling)**
 - **EMC shielding and thermal stability assessed**
 - **Multipactor and corona levels determined for HPIs**
- **Ka band isolator in QPL since june 2016**
- **S&C band HPI qualification planned end 2016**



Next steps -> Developments for Integration & Miniaturization

- **High Power Isolator with reduced footprint (CNES support)**
- **Iso divider**



Thank you for your attention !